



Professional heating and cooling solutions

Grupa proizvoda: "**Luxline cassette FC**" - Kazetni ventilokonvektor s motornim žaluzinama

TIP UREĐAJA:	SLIKA:	MODEL:	HLAĐENJE	GRIJANJE	CIJENA Kn:
			W	W	Kn
Kazetni ventilokonvektor (fan coil) 2-cijevni		LCF-34KM-2	2100	3300	2.415 kn
		LCF-51KM-2	2850	4550	2.527 kn
		LCF-68KM-2	3700	6150	2.640 kn
		LCF-85KM-2	4850	7850	2.976 kn
		LCF-102KM-2	5630	9289	3.875 kn
		LCF-136KM-2	7250	11800	4.100 kn
		LCF-170KM-2	9100	13600	4.212 kn
		LCF-204KM-2	11000	16900	4.324 kn
		LCF-238KM-2	12600	18900	4.437 kn
Kazetni ventilokonvektor (fan coil) 4-cijevni		LCF-34KM-4	1580	1340	2.640 kn
		LCF-51KM-4	2140	1820	2.752 kn
		LCF-68KM-4	2780	2360	2.864 kn
		LCF-85KM-4	3640	3090	3.201 kn
		LCF-102KM-4	4220	3590	3.987 kn
		LCF-136KM-4	5440	4620	4.324 kn
		LCF-170KM-4	6820	5250	4.437 kn
		LCF-204KM-4	8250	6610	4.661 kn
		LCF-238KM-4	9440	7290	4.774 kn

Daljinski upravljač

LCF-RC-08

223,00 kn

Grupa proizvoda: "**Luxline Pilote cassette FC**"

Kazetni ventilokonvektor s motornim žaluzinama i ispuhom na 8 strana

TIP UREĐAJA:	SLIKA:	MODEL:	HLAĐENJE	GRIJANJE	CIJENA Kn:
			W	W	Kn
Kazetni ventilokonvektor (fan coil) 2-cijevni		LCF-34KM-2	2100	3300	2.753 kn
		LCF-51KM-2	2850	4550	2.881 kn
		LCF-68KM-2	3700	6150	3.009 kn
		LCF-85KM-2	4850	7850	3.393 kn
		LCF-102KM-2	5630	9289	4.418 kn
		LCF-136KM-2	7250	11800	4.674 kn
		LCF-170KM-2	9100	13600	4.802 kn
		LCF-204KM-2	11000	16900	4.930 kn
		LCF-238KM-2	12600	18900	5.058 kn

Daljinski upravljač

LCF-RC-08

223,00 kn



Professional heating and cooling solutions

Grupa proizvoda: "Ecoline FC" - Univerzalni ventilokonvektor  
model s doljnim usisom zraka

TIP UREĐAJA:	SLIKA:	MODEL:	HLAĐENJE	GRIJANJE	CIJENA Kn:
			W	W	Kn
Univerzalni ventilokonvektor (fan coil) 2-cijevni		EFC-34ZDM-2	1750	3300	1.174 kn
		EFC-51ZDM-2	2680	4550	1.312 kn
		EFC-68ZDM-2	3640	6150	1.520 kn
		EFC-85ZDM-2	4480	7850	1.658 kn
		EFC-102ZDM-2	5350	9289	1.796 kn
		EFC-136ZDM-2	7180	11800	2.349 kn
		EFC-170ZDM-2	8950	13600	2.487 kn
		EFC-204ZDM-2	10600	16900	2.763 kn
		EFC-238ZDM-2	12000	18900	2.901 kn
Univerzalni ventilokonvektor (fan coil) 4-cijevni		EFC-34ZDM-4	1750	1340	1.382 kn
		EFC-51ZDM-4	2680	1820	1.520 kn
		EFC-68ZDM-4	3640	2360	1.658 kn
		EFC-85ZDM-4	4480	3090	2.003 kn
		EFC-102ZDM-4	5350	3590	2.141 kn
		EFC-136ZDM-4	7180	4620	2.556 kn
		EFC-170ZDM-4	8950	5250	2.694 kn
		EFC-204ZDM-4	10600	6610	3.039 kn
		EFC-238ZDM-4	12000	7290	3.178 kn

**Dodatni pribor i oprema:**

Nogice za montažu na pod	WMU-FEET	81,00 kn
Sakuplj.kondenzata, vert.ugradnja	EDPV-WA(M)U	-
Dodatni izmjenjivač za grijanje	WA(M)U L1-34	-
Dodatni izmjenjivač za grijanje	WA(M)U L1-51-68	-
Dodatni izmjenjivač za grijanje	WA(M)U L1-85-102	-
Dodatni izmjenjivač za grijanje	WA(M)U L1-136-170	-
Elektronika s dalj.upravljačem za 2 cij.s.	WA(M)U-PCW-V	-
Elektronika s dalj.upravljačem za 4 cij.s.	WA(M)U-PCW-P	-
El.grijač 1 kW	WA(M)U-EH-1	-
El.grijač 1,5 kW	WA(M)U-EH-1,5	-
El.grijač 2 kW	WA(M)U-EH-2	-



Professional heating and cooling solutions

Grupa proizvoda: "**MFP FC**" - Ultratanki ventilokonvektor s usmjerivom al.žaluzinom model s prednjim usisom zraka, nogicama i ugrađenim termostatom

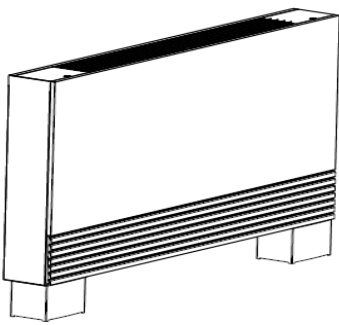
TIP UREĐAJA:	SLIKA:	MODEL:	HLAĐENJE	GRIJANJE	CIJENA Kn:
			W	W	Kn
Univerzalni ventilokonvektor (fan coil) 2-cijevni		MFP20-UVM	1000	1500	2.000 kn
		MFP30-UVM	1900	2850	2.200 kn
		MFP40-UVM	2800	4200	2.400 kn
		MFP50-UVM	3500	5250	2.600 kn
		MFP60-UVM	4000	6000	2.800 kn
		MFP70-UVM			
		MFP80-UVM			
		MFP90-UVM			
		MFP100-UVM			

temp.vode °C ulaz/povrat

7/12°C

60/55°C

Napredni digit.termostat je ugrađen i uključen u cijenu uređaja

Grupa proizvoda: "**MFP BM**" - Zidni ventilokonvektor s usmjerivom žaluzinom

TIP UREĐAJA:	SLIKA:	MODEL:	HLAĐENJE	GRIJANJE	CIJENA Kn:
			W	W	Kn
Zidni ventilokonvektor (fan coil) 2-cijevni		MFP-34BM-C	1800	2700	1.724 kn
		MFP-51BM-C	2700	4050	1.739 kn
		MFP-68BM-C	3600	5400	2.052 kn
		MFP-85BM-C	4500	6750	2.095 kn
		MFP-102BM-C	5400	8100	2.323 kn
		MFP-136BM-C	7200	10800	2.380 kn

Daljinski upravljač

LCF-RC-08

223 kn



Professional heating and cooling solutions

Grupa proizvoda: **"Zračna zavjesa s EC motorom"** - do 4 m visine  
modeli: **C**-ambijentalna, **E**-s el.grijačem, **W**-s vodenim izmjenjivačem



TIP UREĐAJA:	SLIKA:	MODEL:	HLAĐENJE	GRIJANJE	CIJENA Kn:
			W	kW	Kn
Zračna zavjesa s DC motorom 100/160/210 cm		WING W100 EC		4,0-17,0	3.772 kn
		WING W150 EC		10,0-32,0	4.662 kn
		WING W200 EC		17,0-47,0	5.771 kn
		WING E100 EC		2,0/4,0	3.772 kn
		WING E150 EC		4,0/8,0	4.662 kn
		WING E200 EC		6,0/9,0	5.771 kn
		WING C100 EC		0	3.108 kn
		WING C150 EC		0	4.007 kn
		WING C200 EC		0	4.889 kn

**Dodatni pribor i oprema:**

Nosači zračne zavjese	199 kn
Senzor za vrata	69,00 kn
Zidni kontroler (mrežni rad)	569,00 kn



Professional heating and cooling solutions

Digitalni termostati za ventilokonvektor		Zidno/ ugradbeni	TL108	257,00 kn
		zidni	TL107	212,00 kn
		touch screen	TL2018	549,00 kn

**3 smjerni ventil s by-passom**

	TL-G1/2	392,00 kn
	TL-G3/4	437,00 kn

**Thermal solarni paneli 2.09m2**

	TSP 2	1.600,00 kn
-------------------------------------------------------------------------------------	-------	-------------